

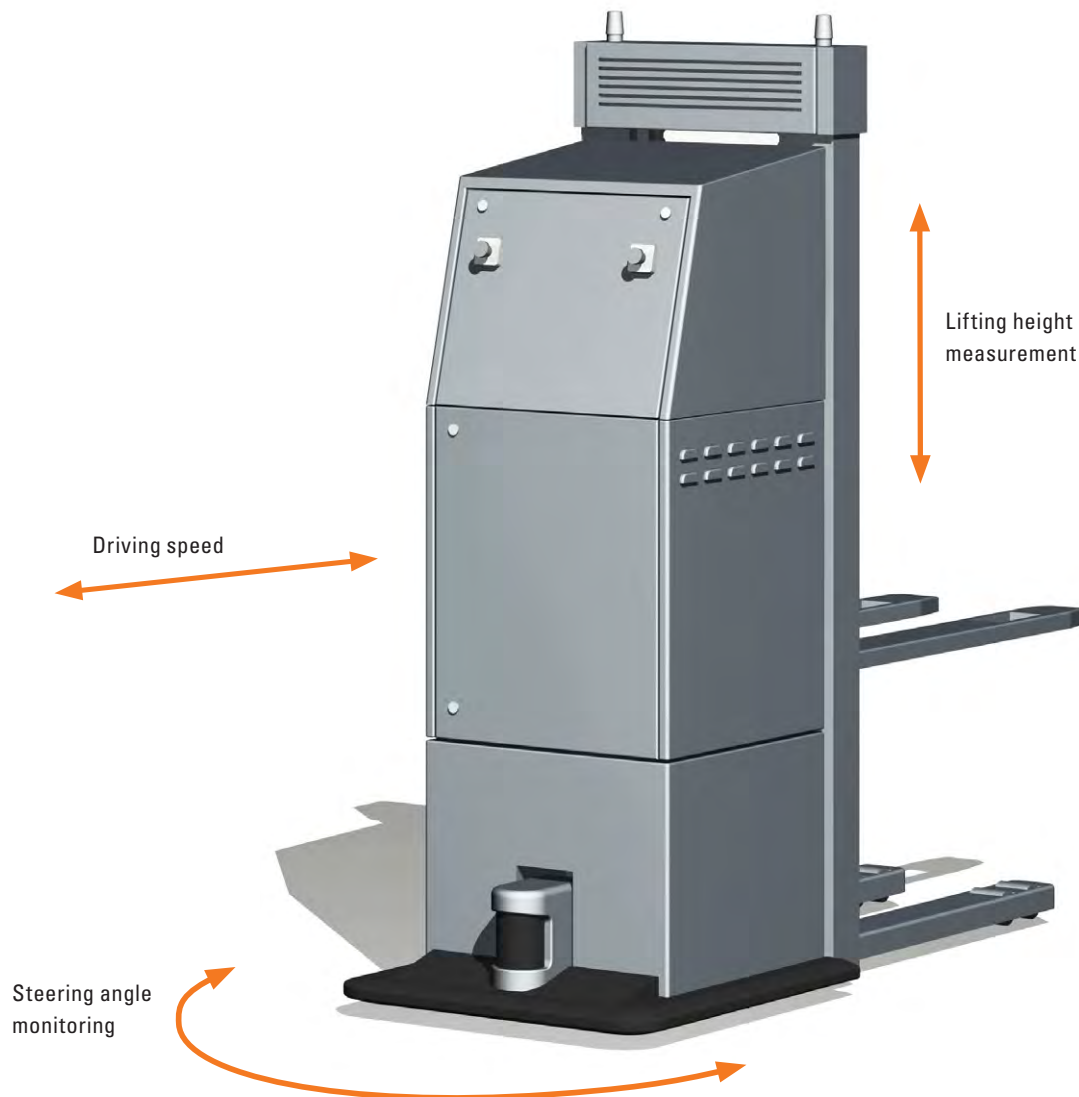

- Driving speed measurement and steering angle monitoring with encoders
- Lifting height measurement with draw-wire encoders

Automatic guided vehicles

Compact encoders and draw-wire systems of Kübler are used to determine the speed, the steering angle of the vehicles and the exact position of the load-carrying devices. Their accurate rotary speed and position signals ensure the reliable operation of the intelligent systems - even when only very little space is available. BUS systems ensure the safe signal transmission and simplify notably the cabling work.



DRAW WIRE ENCODERS COMPACT & PERFORMANCE

Encoder / Sensor

Incremental
Analog
SSI
CANopen
SAE J1939
IO-Link
PROFIBUS DP
EtherCAT
PROFINET IO
EtherNet/IP
Modbus

Incremental
Analog
SSI
CANopen
SAE J1939
IO-Link

Analog

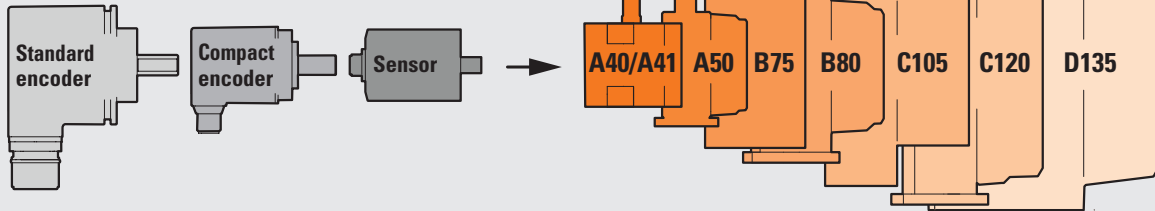

Draw wire mechanics

Lifting height measurement



Linear measurement up to 3 or 6 m, absolute value acquisition via fieldbus, high accuracy

Draw-wire encoder A41

- Measuring length 2 m
- CANopen interface
- Robust housing
- High dynamic up to 1 m/s



Draw-wire encoder B75

- Measuring length 3 m
- Fieldbus interface
- With optical multiturn encoder
- Robust housing
- Linearity up to $\pm 0.35\%$ of the measuring range



Draw-wire encoder B80

- Measuring length 3 m
- Fieldbus interface
- Interchangeable installation
- With optical multiturn encoder
- Robust housing
- Linearity up to $\pm 0.02\%$ of the measuring range



Draw-wire encoder C120

- Measuring length 6 m
- Fieldbus interface
- Interchangeable installation
- With optical multiturn encoder
- Robust housing
- Linearity up to $\pm 0.02\%$ of the measuring range



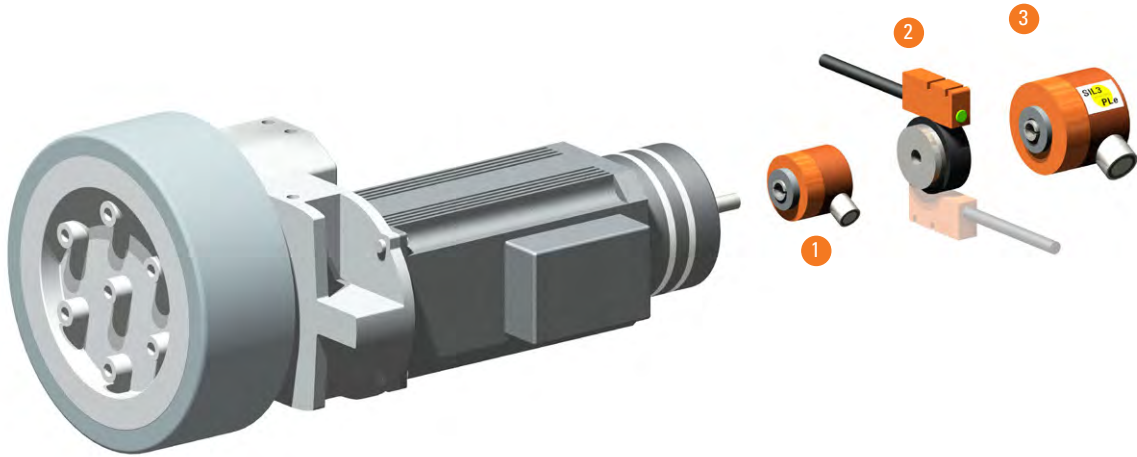

Driving speed



Dynamic rotary speed measurement with reduced space requirements in hollow shaft version

Sendix S3674 Motor Feedback System ¹

- Singleturn encoder \varnothing 36 mm
- SIL2/PLd
- Operating temperature -30°C ... +120°C
- Accurate optical scanning
- Tapered shaft \varnothing 8 mm



Sendix Base KIH40 encoder ¹

- Incremental encoder \varnothing 40 mm
- Optical scanning
- Safety Lock™
- Resolution max. 2500 ppr



RI120 bearingless encoder ²

- Magnetic scanning
- Resolution max. 3600 ppr
- High protection level up to IP69k



Sendix 5834FS encoder ³

- Incremental encoder \varnothing 58 mm
- Accurate optical scanning
- SIL2/PLd, SIL3/PLe
- Resolution max. 2048 ppr



Steering angle monitoring



Absolute angle measurement with fieldbus control, robust encoder with reduced space requirements

Sendix M36 encoders ⁴

- ø 36 mm size
- CANopen interface
- Magnetic scanning
- Safety-Lockplus™
- High protection level IP69k
- Status display



Sendix F5888 encoder ⁴

- ø 58 mm size
- CANopen interface
- Optical scanning







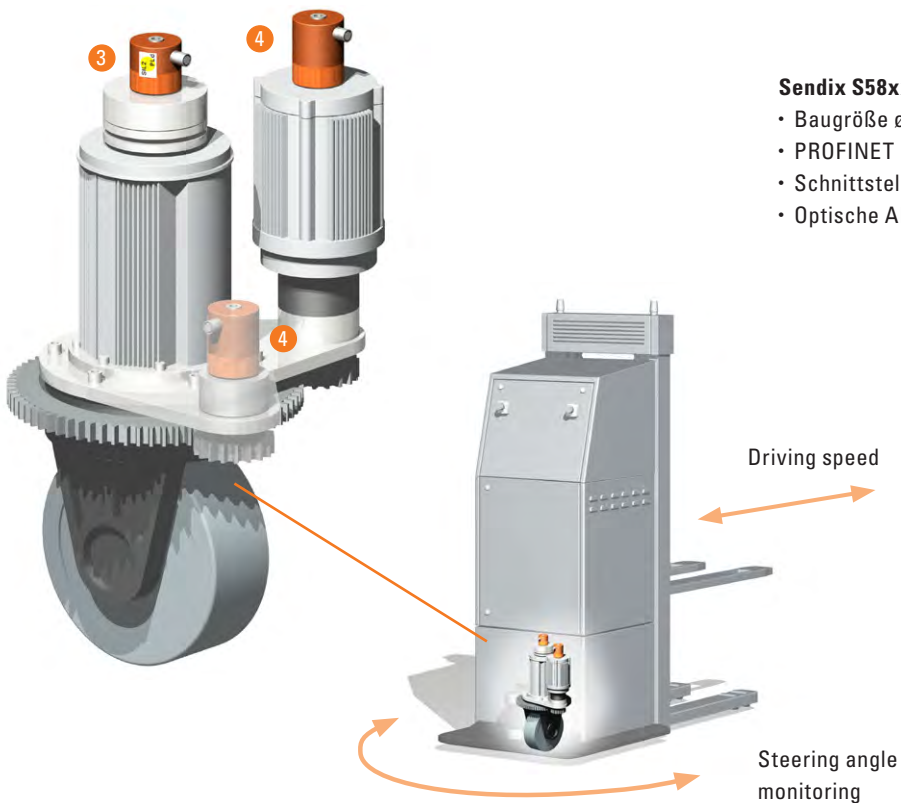







Sendix S58xxFS3 Drehgeber ⁴

- Baugröße ø 58 mm
- PROFINET IO / PROFIsafe
- Schnittstelle
- Optische Abtastung



Portfolio overview draw-wire encoders

	Characteristics			Draw-wire encoders			Measuring length														
	Linearity max.	Speed [m/s]	Wire diameter [mm]	Measuring length [m]			Short range			Mid range				Long range							
					Encoder	Analog sensor	Features	0	1	2	3	4	5	6	8	10	12	15	max. 42.5		
Performance-Line	±0.02 %	10	0.5		A50	INC ABS	U I R	[0, 1]													
					B80	INC ABS	U I R	[0, 3]													
					C120	INC ABS	U I R	[0, 6]													
					D135	INC ABS	U I R	[0, 42.5]													
Robust-Line	±0.1 %	3	1.0		C60	ABS	U I R	RED	[0, 4]												
			1.5		D120	ABS	U I R	RED	[0, 10]												
Compact-Line	±0.3 %	3	0.9		A30		U I R		[0, 1]												
					A40	INC	U I R		[0, 2]												
					A41	ABS	U I R		[0, 2]												
					B75	INC ABS	U I R		[0, 3]												
					C105	INC ABS	U I		[0, 6]												
Base-Line	±0.5 %	1	0.9		C100	INC ABS	U	N RS RED	[0, 5]												
					D125	ABS	U	N RED	[0, 12]												

- INC Incremental
- ABS Absolute, digital
- U Voltage
- I Current
- R Potentiometer
- N Inclinator
- RS Relais / switch output
- RED Redundant sensors

Kübler Service for worldwide planning reliability

24one **24one delivery promise**

Manufacturing in 24 hours. For orders placed on working days before 9 AM, the product will be ready for dispatch on that same day. 24one is limited to 20 pieces per delivery.

10 by 10

We will manufacture and deliver 10 encoders within 10 working days (365 days a year - with the exception of 24th Dec. until 2nd Jan.)

48 h **48 h Express-Service**

We can process your order within 48 hours; we can ship stock items the same day.

Technical Support

Kübler' applications team is present on site all over the world for advice, analysis and support.

Kübler Germany	+49 7720 3903 952
Kübler France	+33 3 89 53 45 45
Kübler Italy	+39 026 423 345
Kübler Poland	+48 61 84 99 902
Kübler Austria	+43 3322 43723 12

Sample Service

We manufacture samples of special designs or according to customer specification within shortest time.

FS **Safety Services**

Individual customer solutions.

KDS **Tailor-made Solutions – Kübler Design System (KDS) OEM Products and Systems (OPS)**

We develop jointly with our customers product and engineering solutions for customer-specific products, integrated drive solutions, up to complete systems.

Kübler Turkey	+90 216 999 9791
Kübler China	+86 10 8471 0818
Kübler India	+91 2135 618200
Kübler USA	+1 855 583 2537



KÜBLER WORLDWIDE

500 EMPLOYEES · 4 PRODUCTION SITES · PRESENCE IN OVER 50 COUNTRIES

EUROPE AUSTRIA · BELARUS · BELGIUM · BULGARIA · CROATIA · CZECH REPUBLIC · DENMARK · ESTONIA · FINLAND · FRANCE · GERMANY · GREAT BRITAIN · GREECE · HUNGARY · ICELAND · IRELAND · LITHUANIA · ITALY · NETHERLANDS · NORWAY · POLAND · PORTUGAL · RUSSIA · SLOVAKIA · SLOVENIA · SPAIN · SWEDEN · SWITZERLAND · TURKEY · UKRAINE **AFRICA** EGYPT · MOROCCO · SOUTH AFRICA · TUNISIA **NORTH AND SOUTH AMERICA** ARGENTINA · BRAZIL · CANADA · MEXICO · PERU · U.S.A. **OCEANIA** AUSTRALIA · NEW ZEALAND **ASIA** CHINA · HONG KONG, CHINA · INDIA · INDONESIA · ISRAEL · LEBANON · MALAYSIA · PHILIPPINES · SINGAPORE · SOUTH KOREA · TAIWAN, CHINA · THAILAND · UNITED ARAB EMIRATES · VIETNAM

KÜBLER GROUP

-  FRITZ KÜBLER GMBH
-  FRITZ KÜBLER SARL
-  KÜBLER ITALIA S.R.L.
-  KÜBLER ÖSTERREICH
-  KÜBLER SP. Z.O.O.
-  KÜBLER TURKEY OTOMASYON TICARET LTD. STI.
-  KÜBLER INC.
-  KÜBLER AUTOMATION INDIA PVT. LTD.
-  KUEBLER (BEIJING) AUTOMATION TRADING CO. LTD.
-  KUEBLER KOREA (BY F&B)
-  KÜBLER AUTOMATION SOUTH EAST ASIA SDN. BHD.

Kübler Group

Fritz Kübler GmbH

Schubertstrasse 47
78054 Villingen-Schwenningen
Germany

Phone +49 7720 3903-0
Fax +49 7720 21564
info@kuebler.com

kuebler.com